

# Air Purifier

## User Manual

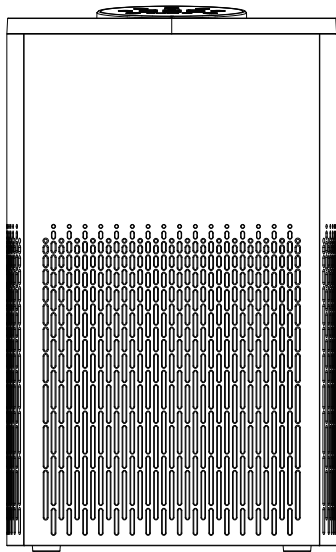

# Contents

Set Up And Usage.....	1
Exploded View Of Purifier .....	2
Principle Of Air Filtration.....	3
Product Specifications.....	4
Button Function Indication.....	4
Instructions.....	5
APP'S User Manual.....	6
Quick guide of using Amazon Echo to control smart devices.....	7
Cleaning Care.....	7
1. Clean the surface and vents.....	7
2. Replace the filter.....	8
3. Long-term idle.....	9
Precautions For Use.....	9
Troubleshooting.....	11
FCC Statement.....	12

## SET UP AND USAGE

It is very effective when used in these places!

- For PM2.5, indoor dust, etc. As PM2.5, dust, etc. are easy to fall near the floor, it is recommended to place this product on a flat floor or table in the room.
- Make the air in the room circulate effectively. Please install this product at a distance of about 30cm or more from walls, furniture, curtains, etc. on the left, right and above, otherwise it will be difficult for pollutants to be sucked into the body.

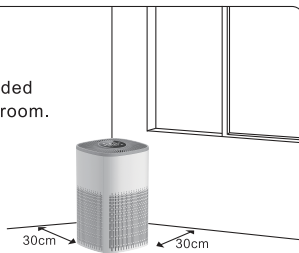

- Do not install this product in the following places.
  1. Places exposed to direct sunlight, blown by air conditioning, or heated. (Otherwise it may cause deformation, aging, discoloration or malfunction.)
  2. Near objects such as televisions and radios. (Otherwise, it may cause image disorder and noise.) → Set at a distance of 1m or more.
- When used in the same place for a long time. The walls and floors around the product will be dirty. It is recommended to change the installation location when performing product maintenance.
- The product should be installed in a place where it can receive wireless router signals. (Otherwise, wireless connection cannot be realized.)
- Do not place objects on the product. (Otherwise, the product may malfunction or malfunction.)
- Do not place obstacles at the air inlet and outlet of the product. (Otherwise, product performance may be affected.)
- Do not use the same power outlet with TV, radio and other equipment. (When the power plug is inserted, the product image may be disordered and noise.) → Please plug the power plug into another power outlet.
- It is recommended that you run it for 24 hours or a long time. Quality-assured household air purifiers are based on the premise that they can be turned on for a long time, so you can turn them on with confidence.

## EXPLODED VIEW OF PURIFIER

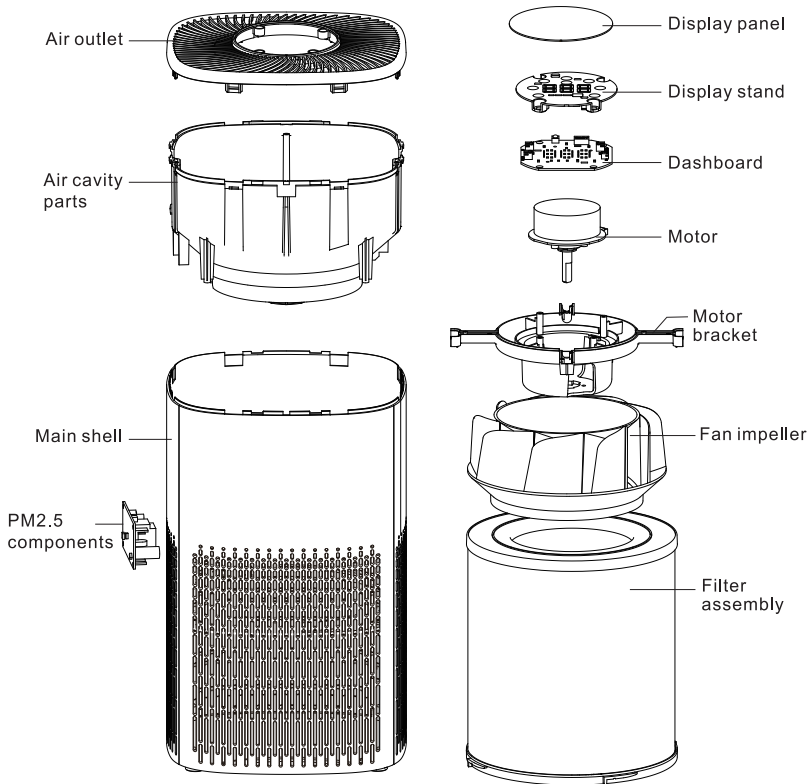

# PRINCIPLE OF AIR FILTRATION

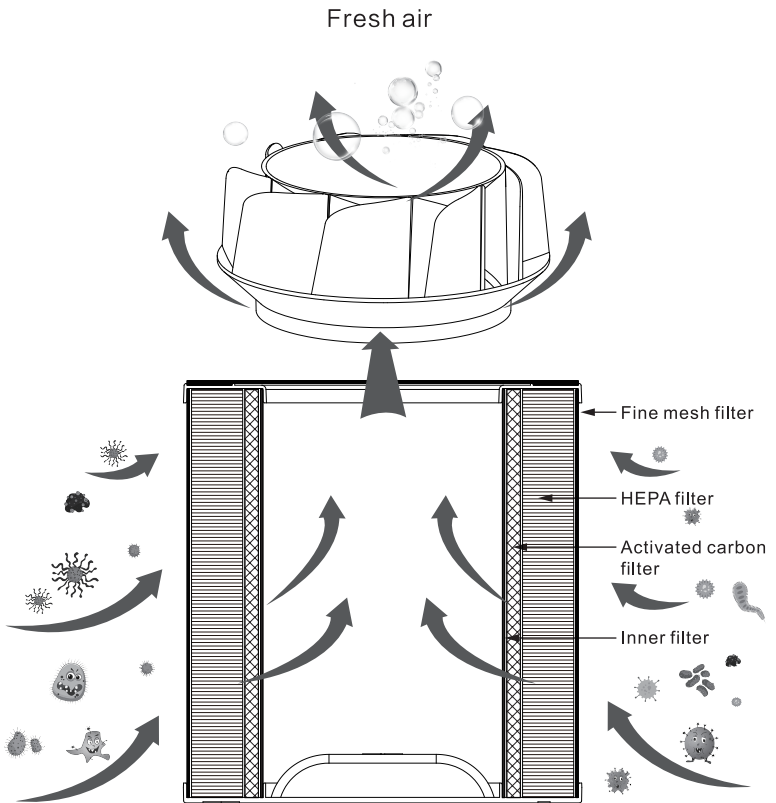







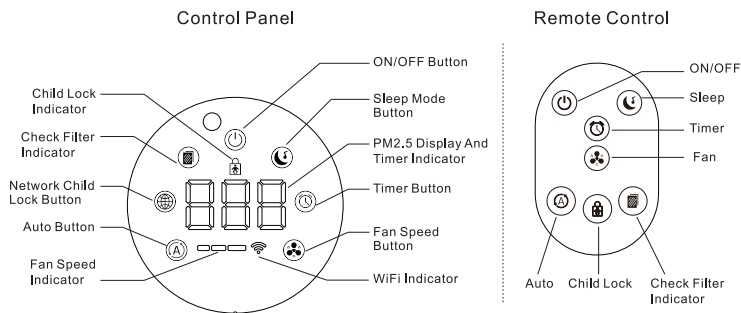

## PRODUCT SPECIFICATIONS

Product size	205x205x340mm (H)
Product weight	Approx. 2100 g
Input	AC 100-240V 50/60Hz
CADR value	210 (m <sup>3</sup> /h)
Application area	Approx 36 square meters(Approx 388 Sq.Ft)
Control mode	APP intelligent remote control, remote control
Distribution network	wifi/wifi+Bluetooth automatic network configuration
PM2.5 display	Digital tube display
Ambient light	LED tricolor light
Sound level	Approx. 30~65db
Actual power	22W
HEPA filter	Round high-efficiency filter (Lifetime 180 days)
Filter type	Formaldehyde, PM2.5, second-hand smoke, pollen
Motor type	Brushless DC motor

## BUTTON FUNCTION INDICATION



-  **ON/OFF Button:** Touch the key to start up or shut down.  
 When it is turned on, it defaults to the second gear air volume.
-  **Sleep Mode Button:** ultra-low noise operation. Touch any key in sleep mode to exit sleep mode.
  - a. Touch for the first time to enter sleep mode.
  - b. Touch the second time, and the first sleep music loops.
  - c. Touch the third time to switch to the second sleep music.
-  **Timer Button:** Press once to view the timing time, and then press it again (within 3 seconds), the timing will be one hour, increase sequentially, and cycle in turn.
-  **Fan Speed Button:** The gear position can be switched in cycles by pressing 2-3-1.
-  **Check Filter Indicator:** The icon of the filter needs to be replaced, which lights up in red. Long press the icon for three seconds to turn white and the filter time has been reset.
-   **Network / Child Lock Button:** Short press three times to open and close the child lock, the operation is effective within three seconds.  
 Long press for three seconds to enter the normal network distribution mode, the WIFI icon is in a fast flashing state (flashing twice per second). Long press for three seconds to enter the compatible network configuration mode, the WIFI icon is in a slow flashing state (flashing once every 3 seconds).
-  **Auto Button:** Smart mode, manual mode switch in turn.  
 Smart mode: Automatically switch the purification efficiency according to the indoor air quality.  
 LED light color display: green for good air quality, orange for light pollution, and red for heavy pollution.

## INSTRUCTIONS

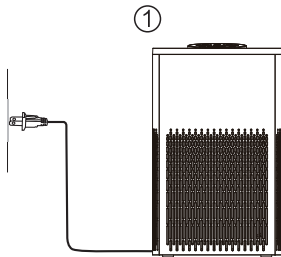

Take out the machine and place it on the platform and connect it to the power supply.

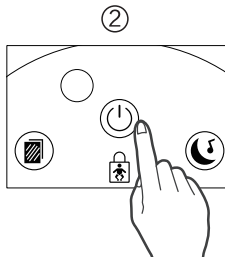

Touch the ON/OFF button to turn on the purifier.



Download "TuyaSmart"  
APP to Control.

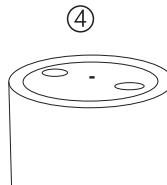

Compatible with Amazon  
Alexa and Google home  
for voice control.

## APP'S USER MANUAL

- Download and install "Tuya Smart" in the mobile application market.
- Use email registration or SMS verification code to log in. If you have already registered, log in directly to use it. If you forget your password, you can reset your account password through the process of retrieving the password.

**Remarks:** APP provides two kinds of network distribution methods: quick connection mode and normal mode.

- Distribution network:

Please make sure that the WI-FI indicator on the machine is flashing quickly (twice per second). If the WIFI indicator is not flashing, press and hold the setting button of the body for 3 seconds to switch to the fast flashing mode.

1. Use "Quick Connect" to configure the network, turn on the phone's Bluetooth, then enter the APP, refresh the interface, the device will automatically pop up, and you can add it.
  2. Use "normal mode" to configure the network, enter the Tuya APP homepage → click on the "+" → at the top right to select small appliances → environment → air purifier, enter the network configuration page, select the device working area and the mobile phone the same WIFI and enter WIFI Click to confirm the password, wait for the connection, add successfully, and click Finish.
- Control device: After the device is successfully configured, the smart device name will appear on the home page, click to enter the smart device control panel for specific operations.
  - The wifi icon is always on when the network is successfully connected, and the wifi icon is off when the network is disconnected.

**Note:** The purifier, mobile phone and router must be in the same network. The connection network only supports 2.4GHz WiFi network, not 5.0GHz WiFi network.



## Quick guide of using Amazon Echo to control smart devices

- Search "Amazon Alexa" in App Store or Google Play to install the app.
  - Make sure your Echo device is energized. Open the Alexa app by tapping the app icon on your mobile device. Type in your Amazon account and password, then tap "SIGN IN".
  - Tap the hamburger menu on the top left corner, select "Settings", then tap "SET UP A NEW DEVICE".
  - Select your Echo model, choose a proper language, then tap "CONNECT TO WI-FI".
  - Long press the dot button on the top of your Echo device until the orange light shows up, then tap "CONTINUE". When your phone is connected to Echo, tap "CONTINUE".
  - Select a Wi-Fi to let Echo have the access to the internet. Type in the Wi-Fi password, then tap "CONNECT". Echo may take several minutes to connect the network.
  - Tap "CONTINUE" when Echo is connected to the network. After an introduction video, tap "CONTINUE" to finish the setup.
  - Tap "Skills" in the hamburger menu, then search "Smart Life". Select "Smart Life" and tap "ENABLE" to enable the Skill.
  - You will be redirected to the account link page. Type in your Smart Life account and password, don't forget to select the country/region where your account belongs to. Then tap "Link Now" to link your Smart Life account. The country/region, the account, and the password must match with the exact contented.
  - Echo needs to discover your smart devices before it controls them. You can say "Alexa, discover devices" to Echo. Echo will discover devices which have already been added in the Smart Life app. You can also tap "DISCOVER" to discover the smart devices. Discovered devices will be shown in the list. Now you can control your smart devices through Echo.
- Note:** The use of "Google Home" to control smart device operation guidelines is similar to Amazon Alexa operation, which can be set according to boot settings.

## CLEANING CARE



Before maintenance, cleaning, and transportation of the product, turn off the product, and unplug the power plug at the same time, ensure the units in a power-off (otherwise, it may run suddenly and cause electric shock or injury).

In order to ensure that the product can work effectively, it is recommended to clean the vent once after 2-3 months of use.

### 1. Clean the surface and vents

※ When used for a while, some tiny particles and dust may accumulate on the product's vents, if in the case:

1. Turn off the machine and unplug the power plug at the same.
2. Press the top edge of the product with one hand, pinch the handle of the filter with the other hand, press down with appropriate force and rotate it counterclockwise, and then take out the filter upwards (as shown on the right).

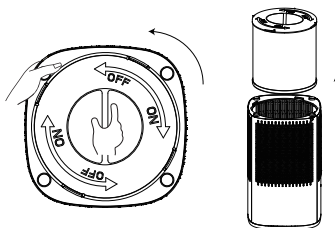

3. First use a vacuum cleaner or a brush to remove the dust on both sides of the vent, and then wipe the surface of the product and the dirt on both sides of the vent with a fully wrung sponge or soft cloth.
4. Please don't let water flow into the units when cleaning, as it may damage its structure, cause unnecessary loss.
5. After the product is wiped, the product must be dried for at least 24 hours before it can be used again.

## 2. Replace the filter

Name	Replacement cycle
Filter	180 working days (red light)

※When the service life of the filter has expired, the filter button will light up in red and the horn will beep five times. The filter replacement is reminded by the built-in program, but due to the different pollution levels of the actual application environment, the life cycle of each filter will also be different, and it can be replaced in time according to the size and smell of the sound produced by the machine.

### 1. Steps to replace the filter

- 1). Turn off the machine and pull out the power plug at the same time, so that the machine is in a power-off state.
- 2). Press the top edge of the product with one hand, pinch the handle of the filter with the other hand, press down with appropriate force and rotate it counterclockwise, and then take out the filter upwards.

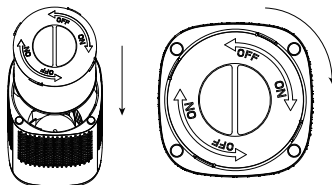

- 3). Put the filter into the machine and turn it clockwise to the buckle. After the filter is rotated in place, you will hear a squeak (as shown in the right picture).

## 2. Reset filter cycle (reset only after 180 working days)

After the filter indicator lights up in red, please plug in the power plug, press and hold  for 3 seconds or enter the APP, click settings, click the filter element to reset, and the filter indicator turns white to complete the reset.

### ATTENTION:

- The used filter cannot be reused even if it is cleaned. Please dispose of it as non-burnable garbage.
- Depending on the place and method of use (such as hotels or households with a large number of smokers), the filter replacement cycle may be shortened. In short, if the effect is not good, please replace it in time. In addition, if you often use it in an environment with strong odors, it is recommended that you open windows for indoor ventilation on a regular basis.

## 3. Long-term idle

1. Switch OFF the unite and unplug the power plug
2. Maintenance is required.
3. Put it in a plastic bag and carton, and store it in a dry place (upside-down or flat placement may cause the product to malfunction).

## PRECAUTIONS FOR USE



Please read this safety instruction before use.

- Please read the instructions below, pay attention to all warnings and keep this document for future reference.
- Please set the unit according to the instruction manual and place it in a stable position to avoid product damage or personal injury due to its falling.
- Do not place the product in an inclined position, a high position such as a shelf, or an unstable place. In case of overturning, it will cause equipment damage or personal injury.
- Do not use this product in a bathroom or a damp environment. Do not use this product in places with water, including places with dripping and splashing (for example, indoor fountains, etc.), and don't place it in a place where there is water. Near liquid containers, such as vases or fish tanks.
- Do not use this product near heat sources (such as radiators, thermal ventilation devices, chemical sprays, stoves, open flames like lighted candles, or other heating devices like audio amplifiers or televisions).

- Do not use wet hands to plug or unplug the power plug, otherwise it will cause electric shock.
- Do not put the plug into the liquid or contact with water, otherwise it will cause electric shock.
- Do not approach heat-generating objects when using the power plug, and do not excessively bend the wires to avoid damaging the wires. Damaged wires may cause electric shock.
- Please stop using the device when the power plug is damaged, loose, or the wire is broken, otherwise it may cause electric shock or fire.
- If the power plug of the product is overheated, odors, noise or other phenomena, please stop using it immediately, pull out the power plug, otherwise it will cause electric shock or fire.
- Do not block the product vents or throw objects into the vents, ports or slots. Doing so may cause the risk of electric shock or fire. To ensure adequate ventilation, keep a distance of at least 30 cm around the device, and do not have obstructions around it. Covering the ventilation openings with items such as newspapers, tablecloths, curtains, etc. may obstruct ventilation and cause a fire.
- Do not block the air outlet. It may hinder the normal operation of the product, cause damage or malfunction, cause overheating and other malfunctions.
- All maintenance and repair work shall be carried out by qualified maintenance personnel. When the product does not work normally, the product meets with water, rain or other liquid, gets damp or falls, it needs to be repaired.
- Please use the voltage within the specified range, otherwise it may cause electric shock, product damage or fire.
- Do not disassemble or modify the internal parts or modify the product without authorization, otherwise it may easily cause product failure, or may cause fire, electric shock, injury and other accidents. when you need to move the product, please turn off all functions and pull out the power plug. otherwise, it is easy to cause product failure, or may cause fire or electric shock.
- When checking, cleaning or replacing the filter, please turn off the machine and unplug the power plug.
- When the machine is working, if there is any abnormal sound or smell, please cut off the power immediately, and then contact the maintenance personnel.
- The doors and windows of the room should be closed when the machine is running, otherwise the efficiency of the machine will be reduced.
- Do not use this product if the filter is not installed after replacement, otherwise the dust removal and purification effect will be lost, and dust entering the product may cause malfunctions.

## TROUBLESHOOTING

When the machine has the following faults, please follow the methods below to troubleshoot. If it cannot be ruled out, please contact the seller or send it to the designated repair center for testing. Confirm the following items before sending for testing.

Symptom	Possible Cause	Solution
The system does not respond or the operation indicator does not light up, the machine does not work	<ul style="list-style-type: none"> <li>● The abnormal cause crashes?</li> <li>● Is the power supply connected correctly?</li> </ul>	<ul style="list-style-type: none"> <li>● After turning off the power for a few minutes, restart the power.</li> <li>● Check the connection status of the power plug and the socket. Just in case, unplug the power plug from the socket and insert it again, and then confirm the connection status.</li> </ul>
The remote control does not work	<ul style="list-style-type: none"> <li>● Is the infrared remote control pointed at the control panel?</li> <li>● The remote control is dead?</li> <li>● The remote control is too far away?</li> </ul>	<ul style="list-style-type: none"> <li>● Adjust the direction.</li> <li>● Replace the remote control battery.</li> <li>● Operate closer to the product.</li> </ul>
The purification effect is not significant, and the air quality is not significantly improved	<ul style="list-style-type: none"> <li>● The machine is not equipped with a filter?</li> <li>● The machine is placed in a small place with obstacles nearby, which will affect the purification effect?</li> <li>● The filter is too dirty?</li> </ul>	<ul style="list-style-type: none"> <li>● Install the filter.</li> <li>● Place the machine in a spacious place, without obstructions around it.</li> <li>● Replace the filter.</li> </ul>
No response to touch buttons	<ul style="list-style-type: none"> <li>● The machine is not connected to the correct power source?</li> <li>● Did not touch the touch button?</li> </ul>	<ul style="list-style-type: none"> <li>● Please check if the power plug is loose.</li> <li>● Please touch the button surface for more than 0.3s.</li> </ul>
There is a peculiar smell at the air outlet	<ul style="list-style-type: none"> <li>● There are more sources of pollution in the room?</li> <li>● Is the filter heavily contaminated?</li> </ul>	<ul style="list-style-type: none"> <li>● Open the window for ventilation.</li> <li>● Replace with a new filter.</li> </ul>
Loud running noise	<ul style="list-style-type: none"> <li>● There is debris in the machine?</li> </ul>	<ul style="list-style-type: none"> <li>● Remove debris.</li> </ul>

## FCC STATEMENT

This device complies with part 15 of the FCC rules. Operation is subject to the following two conditions: (1) this device may not cause harmful interference, and (2) this device must accept any interference received, including interference that may cause undesired operation.

Changes or modifications not expressly approved by the party responsible for compliance could void the user's authority to operate the equipment.

**NOTE:** This equipment has been tested and found to comply with the limits for a Class B digital device, pursuant to part 15 of the FCC Rules. These limits are designed to provide reasonable protection against harmful interference in a residential installation. This equipment generates uses and can radiate radio frequency energy and, if not installed and used in accordance with the instructions, may cause harmful interference to radio communications. However, there is no guarantee that interference will not occur in a particular installation. If this equipment does cause harmful interference to radio or television reception, which can be determined by turning the equipment off and on, the user is encouraged to try to correct the interference by one or more of the following measures:

- Reorient or relocate the receiving antenna.
- Increase the separation between the equipment and receiver.
- Connect the equipment into an outlet on a circuit different from that to which the receiver is connected.
- Consult the dealer or an experienced radio/TV technician for help.

The device has been evaluated to meet general RF exposure requirement. The device can be used in portable exposure condition without restriction.

英文版说明书  
3mm出血位

成品尺寸：120X150mm